



PEERLESS[®]
A **KITO** GROUP COMPANY

CHAIN SLING USER'S MANUAL

foreword

For many years we have worked closely with all industries to assist them in proper selection, use and maintenance of chain slings. Thousands of companies have accepted our recommendations, and as a result have enjoyed excellent safety records in materials lifting operations.

The Occupational Safety and Health Administration (OSHA) makes it the legal responsibility of chain sling users to comply with the requirements of 1910.184. Disregard of OSHA regulations by chain sling users can result in the levying of heavy fines, amounting to thousands of dollars. *Download this standard from www.OSHA.gov or you can view this standard on our website at www.peerlesschain.com.

As a chain manufacturer, Peerless Industrial Group produces and delivers the finest products available for lifting and rigging. But, quality products, good design and careful inspection procedures do not eliminate the user's responsibility and the hazards of lifting and improper rigging. With OSHA serving as a guide, we believe the reduction of lifting hazards can be achieved by combining the use of quality products with knowledge, intelligence, proven practices, care, and common sense.

Our warnings are intended to identify those risks which are the most common. We are not responsible for the end user's assembly in which our chain may be used. Failure of the product can occur due to misapplication, abuse, intentional alteration or improper maintenance. Product failure can result in property damage, personal injury or death.



WARNING

-
- 2** Failure to read, understand and follow the instructions in this booklet could result in serious physical injury and property damage.

It is essential that personnel be thoroughly trained in the proper operation of lifting equipment and the handling of loads. Extreme care is necessary to offset the hazards of overloading by improper hitching, obstruction free passage of the load, and using equipment or materials for purposes other than those for which they have been designed.

Thus, the objective of this Chain Sling User's Manual is to impart a knowledge of chain sling properties and the proper use, care and maintenance of chain slings. It is also intended to assist the chain user to evaluate loads and to adopt lifting practices that will conform to safety requirements.

The material presented in this manual represents interpretation of the law as it presently applies to chain sling selection and use. Future developments will be reported in advertising and trade literature to further assist chain sling users in meeting OSHA requirements for lifting and hoisting.

Table of Contents	Page
Chapter 1. Principal Chain Requirements	4
Chapter 2: Basic Safety Guidelines	12
Chapter 3. Evaluating the Load	13
Chapter 4. Selecting the Proper Sling	16
Chapter 5. Rigging	23
Chapter 6. Inspection	27
Chapter 7. Inspection Procedures	28
Chapter 8. Ways to Avoid Chain Failure	31
Chapter 9. 25 Things to Consider When Creating a Lift Plan ..	34
Glossary of Terms	37
Industry Standards	47
Custom Lifting Device and Distribution Centers .	60

Principal Chain Requirements

Essential compliance with OSHA requirements can be accomplished by adopting the following 24 recommendations, 20 of which are classified as “Do’s” and 4 as “Don’ts”.

Do

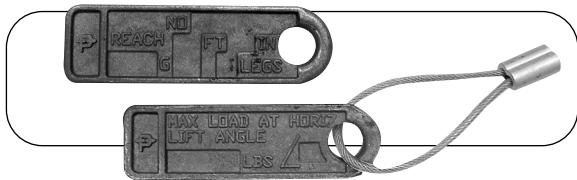

1. Have permanently affixed durable and legible identification tags on alloy steel chain slings stating name of manufacturer, size, grade, rated capacity at a given angle, reach and serial number.
2. Use alloy steel chain slings for lifting loads equal to or less than the rated capacities prescribed in Table 1, Page 5.
3. Use slings not included in Table 1 only in accordance with the manufacturer’s recommendations.
4. Reduce the rated capacity of the alloy steel chain sling to the rated capacity of the weakest component(s) when the component(s) have a lower rated capacity than the alloy steel chain. This includes hooks, rings, oblong links, pear shaped links, welded or mechanical coupling links, or other attachments.



WARNING

- 4 Failure to read, understand and follow the instructions in this booklet could result in serious physical injury and property damage.

Table 1

Working Load Limits - Grade 80 & 100 Alloy Chain

SIZE	Single Leg Sling			Double Leg Sling			Triple and Quad Leg Sling		
	90°	60°	45°	60°	45°	30°	60°	45°	30°
7/32" (6mm)	2,100	3,600	3,000	2,100	5,500	4,400	3,200	4,400	3,200
9/32" (7mm)	3,500	6,100	4,900	3,500	9,100	7,400	5,200	7,400	5,200
3/8" (10mm)	7,100	12,300	10,000	7,100	18,400	15,100	10,600	15,100	10,600
1/2" (13mm)	12,000	20,800	17,000	12,000	31,200	25,500	18,000	25,500	18,000
5/8" (16mm)	18,100	31,300	25,600	18,100	47,000	38,400	27,100	38,400	27,100
3/4"	28,300	49,000	40,000	28,300	73,500	60,000	42,400	60,000	42,400
7/8"	34,200	59,200	48,400	34,200	88,900	72,500	51,300	72,500	51,300
1"	47,700	82,600	67,400	47,700	123,900	101,200	71,500	101,200	71,500
1 1/4"	72,300	125,200	102,200	72,300	187,800	153,400	108,400	153,400	108,400
1 1/2"	100,000	173,200	141,400	100,000	259,800	212,100	150,000	212,100	150,000
1 3/4"	131,250	227,300	185,600	131,250	341,000	278,400	196,900	278,400	196,900
2"	175,000	303,100	247,500	175,000	454,600	371,200	262,500	371,200	262,500
7/32" (6mm)	3,200	5,500	4,500	3,200	8,300	6,800	4,800	6,800	4,800
9/32"	4,300	7,400	6,100	4,300	11,200	9,100	6,400	9,100	6,400
5/16"	5,700	9,900	8,100	5,700	14,800	12,100	8,500	12,100	8,500
3/8"	8,800	15,200	12,400	8,800	22,900	18,700	13,200	18,700	13,200
1/2"	15,000	26,000	21,200	15,000	39,000	31,800	22,500	31,800	22,500
5/8"	22,600	39,100	32,000	22,600	58,700	47,900	33,900	47,900	33,900
3/4"	35,300	61,100	49,900	35,300	91,700	74,900	53,000	74,900	53,000
7/8"	42,700	74,000	60,400	42,700	110,900	90,600	64,000	90,600	64,000
1"	59,700	103,400	84,400	59,700	155,100	126,600	89,550	126,600	89,550
1 1/4"	90,400	156,600	127,800	90,400	234,900	191,700	135,600	191,700	135,600

*Large diameter chain manufactured at our Jeanette facility. *These limits must not be exceeded. Manufacturers do not accept any liability for damages which may result from chain used in excess of working load limits. When using hooks in a shortening (grab) or choker application, the Working Load Limit (WLL) of the sling must be reduced by 20%. The V10 Grade Eye & Clevis Shortening Grab Hooks found in our catalog require no reduction in WLL.

Always consider risk assessment, lift plan and load control.

Principal Chain Requirements

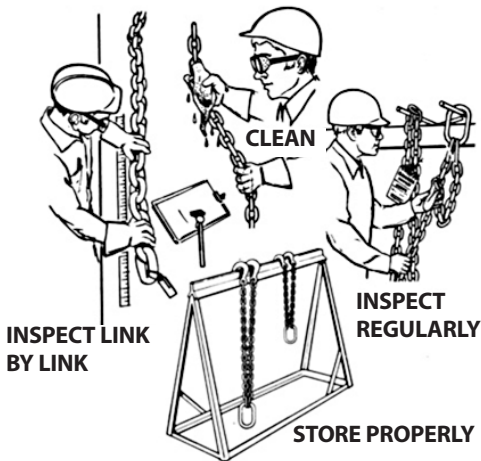

5. Have a competent person, as designated by the employer, inspect the sling and all components for damage or defects each day prior to use.
6. Have a competent person perform and document a thorough visual inspection of each chain sling at least once every 12 months. The inspection schedule should be based on frequency of sling use, severity of service conditions, and nature of lifts being made.
7. Maintain a record of all documented inspections for each individual sling.
8. Remove damaged and defective alloy steel chain slings from service immediately.



WARNING

- 6 Failure to read, understand and follow the instructions in this booklet could result in serious physical injury and property damage.

Principal Chain Requirements

9. Implement, complete, and maintain a record of the most recent month in which each alloy steel chain sling was thoroughly inspected and have such records available for examination.

10. Ensure that each new, repaired or reconditioned alloy steel chain sling has been proof tested, including all welded components in the sling assembly, in accordance with ASTM A391, A973, A906, ASME B30.9 and OSHA 1910.184.

11. Reduce the Working Load Limit (WLL) of a sling 20% when using non-cradle or non-shortening grab hooks in a shortening or choker application.



Principal Chain Requirements

Date: _____	Chain Sling Registration No. _____
CHAIN SLING TEST CERTIFICATE	
<p>This is to certify that Peerless Industrial Group has subjected the alloy chain and sling components used in this assembly to the appropriate quality tests in accordance with ASTM Designation A329 and the pertinent OSHA requirements for alloy steel chain slings.</p>	
Peerless Industrial Group _____	Distributor: _____
<p>The working load limit of the chain and component shown herein is established as pounds applied tensile load to the indicated degree from horizontal. PROPER MODIFICATIONS OF THIS WORKING LOAD LIMIT SHOULD BE CALCULATED OR OBTAINED FROM PEERLESS INDUSTRIAL GROUP CHARTS TO COMPENSATE FOR ADDED STRESS WHEN USED AT OTHER ANGLES. (See chart reverse side). Serious injury can result from exceeding the Working Load Limit of this chain sling.</p>	
Customer's Name: _____	
Customer's Order No. _____	This is to certify that this certificate, identified by the customer's order number and date, is a component of the chain and components set forth herein.
No. of Slings: _____ Size & Material: _____	
Type and Rank: _____	
Working Load Limit: _____ Pounds	Signature: _____
From Horizontal at _____ Degrees	
	
<p>This sling is subject to the warranty terms on the back of this certificate.</p>	

12. Retain the Certificates of Proof Test for each sling and have them available for examination.

13. Ensure that alloy steel chain slings repaired or reconditioned by welding or heat treating, are repaired, reconditioned and proof tested by a sling manufacturer or equivalent entity.

14. Remove alloy steel chain slings from service if the chain size at any point in a link is less than that stated in Table 2 (Table of Wear), Page 11.

15. Reduce the rated capacities permitted in Table 1, in accordance with the recommendations of the manufacturer, of alloy steel chain slings when exposed to temperatures of 400 degrees F or greater, (see Table 3, Page 11).

16. Remove alloy steel chain slings from service permanently if they are heated above 1000° F, in accordance with OSHA 1910.184.



WARNING

Principal Chain Requirements

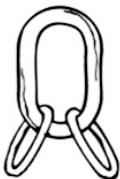

17. Remove from service all alloy steel chain slings with cracked and/or deformation or degradation of components and master links.

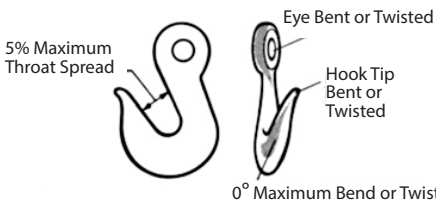

18. Remove alloy steel chain slings from service if hooks are cracked, have been opened more than 5% of the normal throat opening measured at the narrowest point or twisted more than 0 degrees from the plane of the unbent hook.

19. Untwist to assure that all legs of the sling are aligned in the same plane. This will allow for a straight bearing to bearing interlink surface contact for maximum safety and efficiency. (100% bearing surface contact from link to link).

20. Obtain a copy of the Occupational Safety & Health Administration Standard (OSHA 1910.184) for slings from www.OSHA.gov. You can also view this information at www.peerlesschain.com.

Principal Chain Requirements

The Don'ts

- 1. Don't** use Proof Coil, BBB, High Test, Transport (P7) or any other low carbon chain for lifting or hoisting.*
- 2. Don't** use mechanical coupling links or low carbon repair links to repair broken lengths of chain on an alloy chain sling.
- 3. Don't** use makeshift links or fasteners formed from bolts or rods or other such attachments.
- 4. Don't** lift over people and don't ride the load.

Environmental Conditions

In addition to the preceding recommendations, Peerless does not recommend the use of alloy steel chain or chain slings for use in acid or pickling solutions. The high tensile strength of the heat treated alloy material in alloy steel chains is susceptible to hydrogen embrittlement and acidic degradation.

Consider oversized normalized Proof Coil Peerless Chain slings or acid resisting Monel or stainless steel chains and sling components for this service.*

The above restriction also applies to galvanizing operations. The high temperature of the galvanizing bath may permanently reduce the tensile strength of the alloy steel chain material and the galvanizing operation is usually preceded by an acidic cleaning or pickling operation.



WARNING

*Consult manufacturers recommendation.

Table of Wear:

If chain is worn to less than the minimum allowable thickness (T), remove the chain from service.

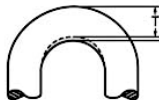

Minimum Allowable Chain Link Thickness at Any Point

Nominal Chain Size		Minimum Thickness	
Inches	mm	Inches	mm
7/32	5.5	0.189	4.8
9/32	7	0.239	6.07
5/16	8	0.273	6.93
3/8	10	0.342	8.69
1/2	13	0.443	11.26
5/8	16	0.546	13.87
3/4	20	0.687	17.45
7/8	22	0.75	19.05
1	26	0.887	22.53
1-1/4	32	1.091	27.71

Refer to ASME B30.9

Effect of Elevated Temperature

Maximum Temp. of Chain	Reduction of WLL while at temp.		Reduction of WLL after exposure to temp.	
	Grade 80	Grade 100	Grade 80	Grade 100
Below 400° F	None	None	None	None
400° F	10%	15%	None	None
500° F	15%	25%	None	5%
600° F	20%	30%	5%	15%
700° F	30%	40%	10%	20%
800° F	40%	50%	15%	25%
900° F	50%	60%	20%	30%
1000° F	60%	70%	25%	35%
Over 1000° F	*(Below)	*(Below)	*(Below)	*(Below)

*OSHA 1910.184 requires all slings exposed to temperatures over 1000°F to be removed from service.

Basic Safety Guidelines

A. LIFT PLAN:

1. Trained/Qualified/Competent Person (Rigger)?
2. Static or Dynamic Lift?
3. Path or Route of the Lift?
4. Approved Rigging Inspected & Tagged?
5. Head Room, Environment, Communication (Signals)?

B. RISK ASSESSMENT:

1. Escape Plan.
2. Fall Radius.
3. Don't place yourself between LOAD & IMMOVEABLE OBJECT!
4. Don't lift or move load over co-workers.
5. Anticipate possible problems – EVERY LIFT IS A RISK!

C. LOAD CONTROL:

1. COG, Center of Gravity (Must Determine).
2. Determine the WEIGHT of the load.
3. Select the proper Rigging, Hitch, WLL and Angle.
4. ALWAYS Rig the load correctly & according to OSHA, ASME & Mfg. REC.
5. Always lift the load level, stable, use tag line if necessary.

EVERY LIFT IS A RISK!



WARNING

Evaluating the Load

Before any lift shall be made, the chain sling user must know as much about the load as possible to minimize potential dangers to personnel, product and property.

The obvious starting point — **know the weight of the load. Don't guess.** In most cases, the company's engineering department will furnish a blueprint of the product or object to be lifted. The blueprint will generally give the weight of the load. Weigh Bills are also a good reference source to provide the weight of a given load.

Another way to estimate the weight of a load prior to lifting is to base load calculations on the weight of a cubic foot of the material.

For example, a cubic foot of steel weighs 500 lbs. approximately. Assume the load being lifted consists of a 9ft x 12ft. steel plate, 1 inch thick.

Thus, the chain sling user calculates as follows:

$$9 \text{ ft.} \times 12 \text{ ft.} \times 1/12 \text{ ft.} = 9 \text{ cu. ft.}$$

$$9 \text{ cu. ft.} \times 500 \text{ lbs./cu. ft.} = 4500 \text{ lbs.}$$

(weight of the load)

Reach and Angle of Lift

Once the weight of the load is known, the user must then determine the type of sling, the reach and angle of lift for the chain sling he selects. The size of the chain can then be determined from Table 1, Page 5.

Evaluating the Load

The reach of the sling and the angle of the lift are related to the distance between the points of attachment to the load.

A sling with a longer reach and a larger angle of lift will permit a greater sling capacity.

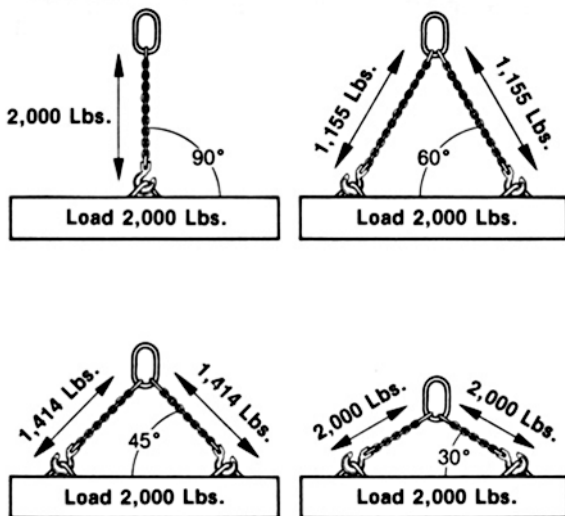

Fig. 1 — The load on each chain leg is increased as the lift angle decreases.



WARNING

Evaluating the Load

A simple method for calculating the rated capacity of a given sling connected to a load is to estimate the distance B (Fig. 2) and then multiply the working limit of the sling at 90 degrees (value of a single chain x number of legs in sling) — from Table 1 — by the ratio of distance B to the reach R. (Check the sling identification tag for reach).

W.L.L. (at 90°) x number of legs x $\frac{B}{R}$ = rated capacity of sling

For example: W.L.L. = 3,250 lbs.

No. of legs = 2, B = 8.5 ft. R = 10ft.

3,250 lbs. x 2 x 8.5/10 = 5,525 lbs. rated capacity

Fig. 2

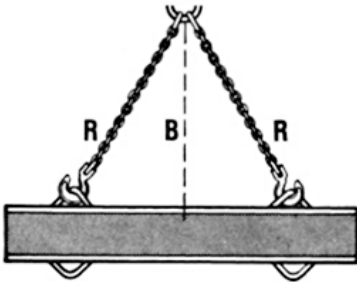

When dimension B is shortened due to a low ceiling and the angles of lift decrease to smaller angles, remember that the load on each leg of the chain will be greatly increased. And, the working load limits of chain slings at these smaller angles of lift will be reduced. Check the working load limit chart on page 5 of this booklet to make sure that the rated working load limit of the chain sling in use at these angles equals or exceeds the weight of the load.

DO NOT go below 30° angle of the lift.

Selecting the Proper Sling

The four most common chain slings are:

- 1. Single** — as the name implies, there is only one chain leg to this type of sling. It consists of a master link, a length of alloy chain, and a hook (there are three types of hooks — sling hooks, grab hooks, and foundry hooks — any of which can be selected depending on the application).



The total weight of the load is carried by the single chain sling. The angle of lift is 90 degrees, and the weight of the load can equal the full working load limit of the chain.

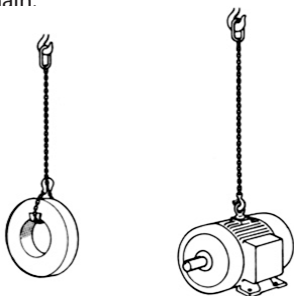

This is a choke hitch.

This is a vertical hitch.



WARNING

Selecting the Proper Sling

2. Double — consisting of two chain legs both connected to a master link at one end and each leg attached to a hook at the other end, the double chain sling is generally used for more applications than any other type.

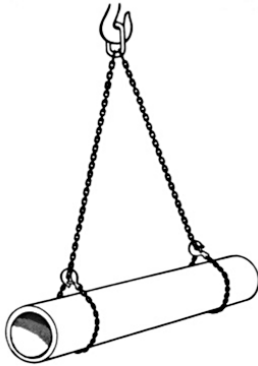

When using a choker hitch in conjunction with a non-cradle grab hook. The capacity must be reduced by 20%. The Angle of Choke must also be at a minimum of 120° or additional reduction must be applied.

Selecting the Proper Sling

- 3. Triple** – the three legged chain sling is often used to improve stability of the load when lifting (load control).

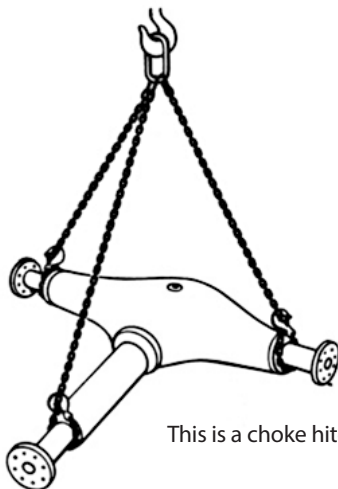
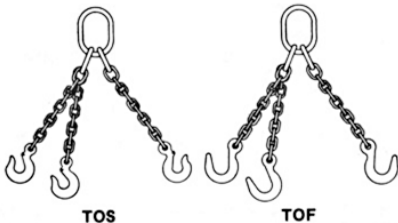

This is a choke hitch.



WARNING

Selecting the Proper Sling

4. Quadruple – a four-legged chain sling has the same rating as a triple since the load is seldom evenly distributed on a quadruple sling. The fourth leg is frequently needed to stabilize a load during the lifting operation.

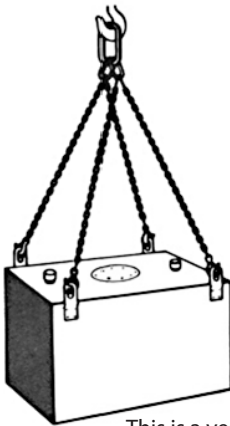

This is a vertical hitch.

Selecting the Proper Sling

Special Purpose Chain Slings

There are four other variations in hitching that are frequently used:

1. Basket hitch — as the name implies, chain is looped basket style around the load. Load must be well balanced to prevent tilting.

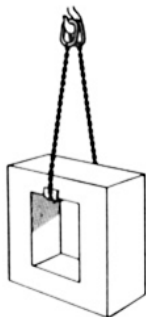

2. Double basket-hitch — works well especially for lifting plates or rods. But, the load must be properly centered because the sling leg angles have to be carefully controlled to guard against any sudden horizontal movement. The legs must be kept far enough apart to provide proper balance for the load

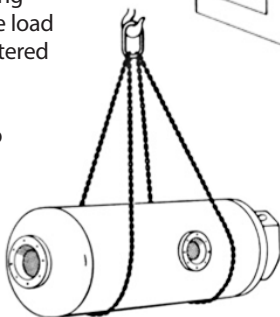

but close enough together to provide sufficient friction to keep them from being pulled in toward the center.

(Consider the D/d ratio for all basket applications.)



WARNING

Selecting the Proper Sling

3. Choker hitch – extremely popular because of the clamping effect of the chain. Its choking action improves the reliability of securement (20% WLL reduction may be required).

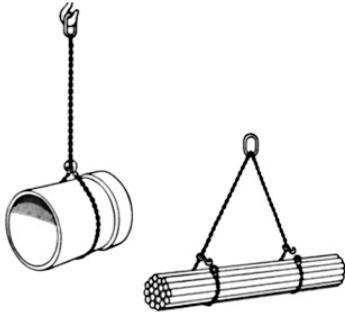

4. Double choker hitch – made for two-point suspension and well suited for handling rods, bars, pipe, etc.

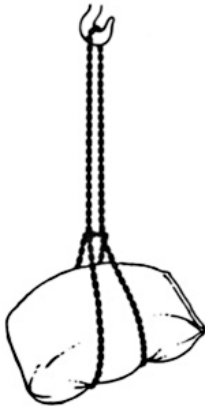

Selecting the Proper Sling

There are many other chain slings and assemblies to choose from for specialized lifting applications. Specials can include adjustable singles, doubles, triples and quadruples; single and endless single basket slings; and chain shorteners — all designed to meet specific lifting applications.



Spreader Beams — A standard spreader beam consists of a structural beam suspended by a two-legged sling. Alloy lifting chains are suspended from the ends of the beam and attached to the load. In this way, there are no compressive forces tending to deform the load.

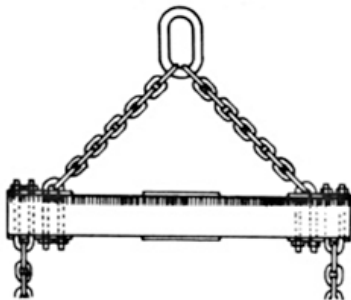

For more information on spreader beams, please refer to the Peerless Below-the-Hook & Material Handling Equipment catalog.



WARNING

22 Failure to read, understand and follow the instructions in this booklet could result in serious physical injury and property damage.

Rigging

It is not possible to cover adequately the subject of safety, the effect of the center of gravity of a body in relation to the lifting points or the distribution of forces in the sling and body, in this small booklet.

It is recommended that everyone involved in the lifting and transporting of articles should familiarize themselves with the fundamentals of safety. However, a few illustrations covering the effect of such forces in equilibrium are shown in the following figures.

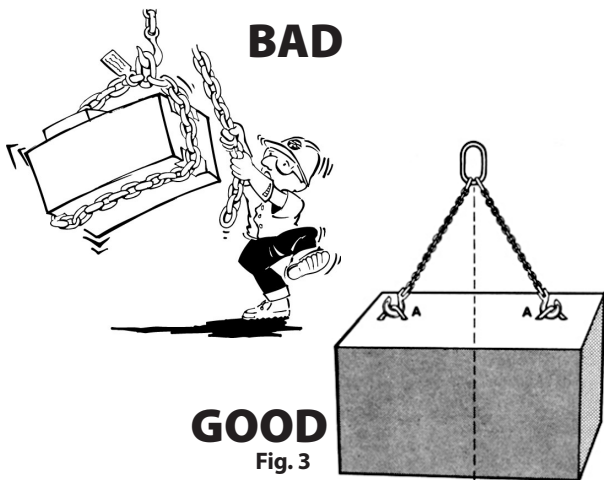

Fig. 3 — The center of gravity of the body is under the crane hook; the angles of lift are equal and each chain leg is carrying the same load.

Rigging

Consider the following: Risk Assessment, Load Control, Lift Plan

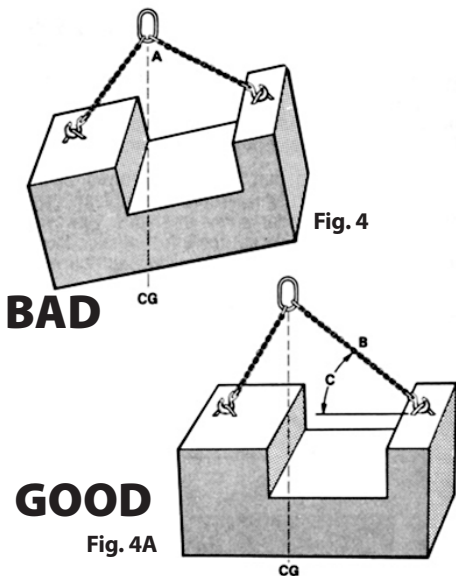

Fig. 4 & 4A — Using equal legged slings, the center of gravity is not in line with the point of lift. The load when lifted will tilt (Fig. 4), until the chain slings (Fig. 4A) having unequal leg length (B) the center of gravity is under the point of lift and the load will balance. The rated capacity of the sling must be based on the smallest horizontal angle. (C).



WARNING

Rigging

Fig. 5 — The center of gravity of the body is above the points of attachment. When lifted, the body would rotate to bring the center of gravity to the lowest point. Whenever possible, have points of attachment above the center of gravity of body.

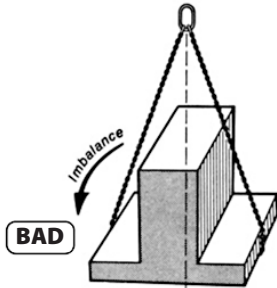

Fig. 5

Fig. 6 — With the two legged sling, the load will tilt and possibly slip from the hooks unless precisely balanced.

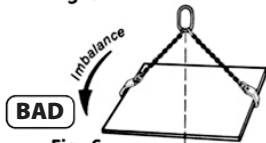

Fig. 6

Fig. 7 — With the three-legged sling, the third leg provides stability. However one leg is carrying half of the weight of the load and the capacity should be based on two-legged sling at (C) horizontal lift angle.

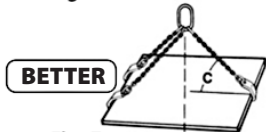

Fig. 7

Fig. 8 — The four-legged sling provides good stability, and the load is equally distributed on each leg.

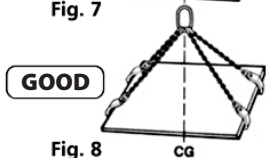

Fig. 8

Rigging

When a load is lifted by a sling, the legs of the sling will exert lifting forces W (fig. 9) on the load to raise it. The legs will also exert forces P (horizontal components of T , the loads on the chain legs). The P forces can crush or deform the load if it cannot withstand these forces (Fig. 9A). When fragile loads are involved, a spreader beam is recommended.

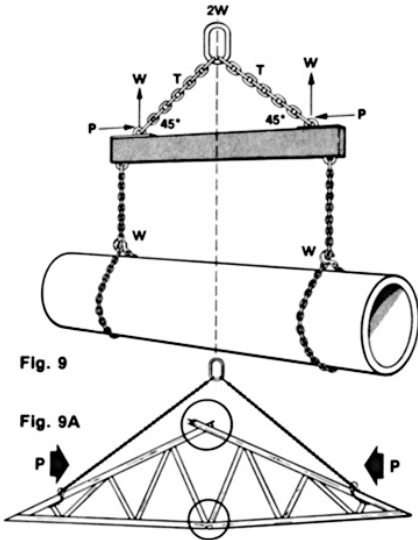

Fig. 9, 9A — The spreader beam is designed to withstand the P forces.

For more information on spreader beams, please refer to the Peerless Below-the-Hook & Material Handling Equipment catalog.



WARNING

Inspection

Inspection records will provide the necessary documentation to meet OSHA requirements and will help in the maintenance to keep chain slings in good condition for material handling.

The responsibility for inspecting slings should be assigned to experienced competent personnel. They should be given the authority to remove damaged slings from service for reconditioning or replacement. Slings removed from service for reconditioning or replacement should be returned to an authorized Peerless Repair Service Center (Contact Peerless for a Repair Service Center in your area.)



**DO NOT ATTEMPT TO
REPAIR CHAIN YOURSELF**

Inspection Procedures

Inspect Regularly



Worn Links



Bent links



Gouged Links



Stretched Links

Inspect for:

1. Wear
2. Nicks & Gouges
3. Stretch
4. Localized Bending
5. Deformation/Degradation
6. Drag Wear
7. ARC Burns
8. Weld Splatter
9. Inner Link Wear
10. Severe Corrosion/Pitting



WARNING

Inspection Procedures

The inspection should follow a formal written inspection procedure to ensure complete examination:

1. Clean chain sling prior to inspection. Chain that is coated with paint, dirt, grease, or oil may hide criteria for removal such as wear, nicks, gouges or other damage.



2. Check the identification tag for legibility. Ensure that the serial number, name or logo of the sling manufacturer, size, grade, working load limit, and reach correspond to the original Chain Sling Certificate when the sling was originally manufactured.
3. Measure the reach of the sling from the bearing of the master link to the bowl of the bottom attachment to make sure they correspond to the values stamped on the chain sling identification tag. If one or more legs are longer, there is a possibility that the sling has been subjected to overloading or excessive wear.

Inspection Procedures

4. Make a link-by-link inspection of the chain slings for:
 - a. Excessive wear. If the wear on any portion of any link exceeds the allowable wear shown on Table 2, Page 11, - remove from service.
 - b. Twisted, bent or cut links.
 - c. Cracks in the weld area or any portion of the link.
 - d. Nicks or gouges.
 - e. Stretched links.
 - f. Severe corrosion.
 - g. Any deformation or degradation of components.
5. Inspect the master and coupling links for wear or damage.
6. If hooks have been opened more than 5% of the normal throat openings (measured at the narrowest point) or twisted more than 0 degrees from the plane of unbent hook, sling shall be removed from service.
7. Attach "Danger — Do Not Use" warning tag (available from Peerless Industrial Group, part number 26.65) to each sling removed from service. Record the removal of the sling on sling inspection report form.
8. Any chain sling removed from service should be tagged and returned to the central issuing department with data covering the damage detected during the inspection. The sling can then be returned to an authorized Peerless Repair Service Center for the appropriate repairs and proof testing.



Ways to Avoid Chain Failure

Chain sling users can help avoid damage and possible accidents by recognizing the following improper practices and preventing their occurrence.

**DO NOT
KNOT
CHAIN**



**DO NOT
TWIST
CHAIN**

- 1. Overloading** — can lead to rapid wear, elongation and possible sling failure.

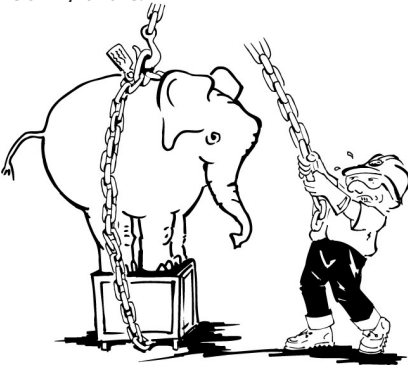

Ways to Avoid Chain Failure

- 2. Improper angle of lift** — small angles of lift result in excessive loads being imposed on each leg of the sling. The results on the sling are the same as for overloading.

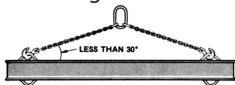

3. Faulty hook-up —

- a.** Point loading of hooks.

Wedging or forcing the hook point into the loads results in the hook bending and failure. Hooks should not face in toward the load.

- b.** Slipping of unbalanced loads. (See Chapter 4 — Rigging).

- c.** Lifting with twisted or knotted chains can impose loads in excess of rated capacity and spin the load dangerously.

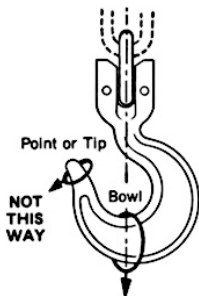

- 4. Impact loading** — jerking or snatching loads (shock loading) when lifting can impose loads on the chain in excess of the actual weight of the object being lifted. These dynamic forces can break or damage the sling.

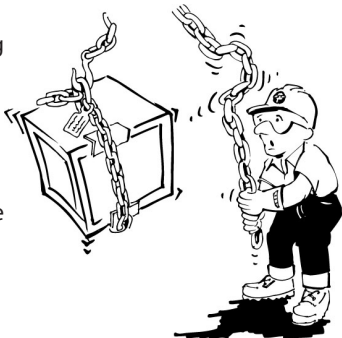

Ways to Avoid Chain Failure

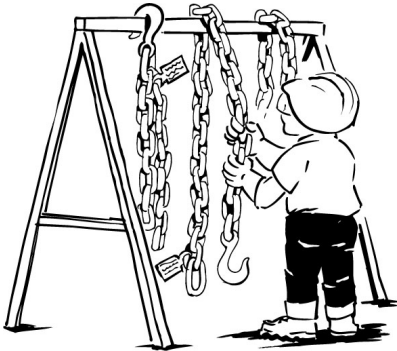

GOOD



BAD

- 5. Improper storage of chain slings** – chain slings placed in areas where loads may be deposited on the sling, where traffic can run over the sling or in areas where they are exposed to corrosive action can severely damage chain slings.

25 Things to Consider When Creating a Lift Plan

1. Determine the weight and balance of all loads prior to a lift to make sure that the lifting equipment can operate within its capabilities.
2. Select only alloy chain slings and never exceed the working load limits for the various sizes and types of chain slings as established by OSHA.
3. Make sure the object being lifted is not lagged, clamped or bolted to the floor.
4. Make sure the hoist or crane is directly over the load.
5. Never lift loads with one leg of a multi-leg sling until the unused legs are made secure.
6. Use multi-leg slings as supplied by the manufacturer rather than combinations of single chains.
7. Use slings of the proper reach. Never shorten a sling by twisting, knotting or with nuts and bolts. Adjustable slings are available for applications requiring slings of varying reaches.
8. Never point-load a hook unless it is especially designed and rated for such use.
9. Remove all loose pieces of material from the load before it is moved.



WARNING

25 Things to Consider When Creating a Lift Plan

- 10.** When lifting long loads particularly in confined spaces, attach a rope or “tag line” to one or both ends of the load so that rotational movement may be controlled.

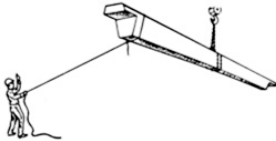

- 11.** Never permit anyone to ride the lifting hook or the load.
- 12.** Make sure that all personnel stand clear while the lift is being made or while the slings are being drawn from beneath the load. The hooks may catch under the load and suddenly fly free (know the fall radius).
- 13.** Do not drag slings along the floor. (Flat Spotting).
- 14.** When wrapping chain around sharp corners, use pads to prevent damage to the links.



- 15.** Authorize only one person to give signals to the crane operator.
- 16.** Before making a lift, check to see that chains are not twisted or knotted and sling is properly attached to the load.

25 Things to Consider When Creating a Lift Plan

17. Before the load is lifted, a place should be prepared where it is to be put down. The nature of the load will determine the type of preparation necessary but most loads should be lowered onto timber battens. The sling can then be easily withdrawn. The load should never be landed directly onto the chain.
18. Avoid impact loading caused by sudden jerking when lifting or lowering — lift the sling gradually until slack is eliminated.
19. Raise the load to a height that is high enough to clear all items in the path of travel.
20. Never work under a suspended load unless the load has been adequately supported from the floor and all conditions approved by the supervisor in charge of the operation.
21. Never leave a load suspended in the air when the hoist or crane is unattended.
22. Never attempt to repair or shorten a sling with bolts, cold shuts, lap links, etc. Repairs or modifications should be performed only at an authorized sling service center.
23. Inspect chain slings thoroughly at specified intervals to maintain them in good condition.
24. Store slings properly on racks or in assigned areas to prevent damage to the slings.
25. Train floor people to be on the lookout for any signs of damaged chain — nicks, gouges, bent or elongated links. Take a damaged sling out of service immediately.



WARNING

Glossary of Most Common Chain Terms

Mechanically Coupled Chain Slings:

An engineered system of forged components that enable the sling user or distributor to assemble standard or special chain slings as required. All components are fully proof tested and have the rated capacity or working load limit of matching alloy steel chain. The chain sling user receives a Test Certificate with each chain sling component.

Components, when used in conjunction with Peerless Grade 80 & 100 chain and assembled by an authorized Peerless Repair Service Center meet ASTM and OSHA proof testing and certification requirements.

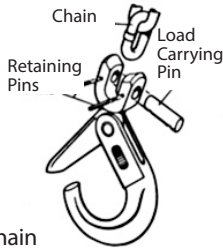

ALLOY STEEL CHAIN: The only chain recommended for overhead lifting.

ANGLE OF LIFT: Measurement of angle between horizontal surface of load and lift chain measured in degrees should never be less than 30 degrees.

Sling Angle Factor: The sling angle factor is a ratio found between the sides of the lift triangle. To find it, divide the sling length by the height of the lift triangle. The height is the distance between the bearing surface of the hook and an imaginary line running from the bearing surface of the attachment points.

Glossary of Most Common Chain Terms



ELONGATION: When chain is severely overloaded or subjected to shock load, elongation of individual links occurs. Peerless welded chain has a minimum elongation factor of 20%. This gives the user an added visual factor to protect people and equipment. Measurable elongation indicates the chain has been severely overloaded and shall be removed from service.



Eye Type



Clevis Type

FOUNDRY HOOK: Designed with a wide, deep throat, it fits trunnions and handles on moulds or castings generally used in foundry work.



Eye Type



Clevis Type

GRAB HOOK: Designed with a special narrow throat and used to shorten or hold a length of chain. The throat engages the chain between the links for quick non-slip handling.



WARNING

Glossary of Most Common Chain Terms



P30 - GRADE 30: (Proof Coil Chain), A low carbon steel general utility chain used for a great many everyday applications. Grade 30 is **not** to be used for lifting or hoisting applications.



P40 - GRADE 43: (High Test Chain), This higher carbon steel chain is significantly stronger than Grade 30, meaning that a lighter chain can often do similar work. Grade 43 is **not** to be used for lifting or hoisting applications.



P7 - GRADE 70: (Transport Tiedown or Binding Chain), A high-strength light-weight steel chain designed for load binding applications. Grade 70 is **not** to be used for lifting or hoisting applications.

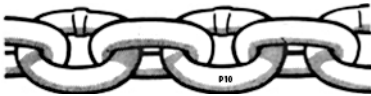

P8 & P10 - GRADE 80 & 100: (High-strength Alloy Chain), Has a high strength-to-weight ratio. Grade 80 & 100 is used predominantly for lifting and hoisting applications and also where optimum wear and strength is required. It is the **only** chain recommended for lifting and hoisting.

Glossary of Most Common Chain Terms

IMPACT: The sudden application of a load, multiplying the stress on the chain very rapidly.

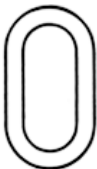

Single Master Link

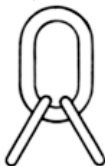

Quad Master Link



Kuplink

MASTER LINK: The large oval or pear shaped link at the top of the sling that slips over the crane hook. The master link carries the chain legs.*

COUPLING LINK:

A flexible mechanical coupling device, generally used to attach chain sling legs to master link and eye type hooks to chains.



PLATE HOOKS: Plate Hooks are intended for use in handling plates, flats, and structurals. Designed for the most popular chain sizes they are proof tested to the same values as the corresponding chain — therefore, the same working load limit applies. Fabricated from alloy steel, plate hooks can be used with various chain assemblies. They can also be furnished on Welded/Registered Chain Slings.

*Check for proper fit and/or seating on all crane hooks



WARNING

Glossary of Most Common Chain Terms

PROOF TEST: The load in pounds which chain has withstood in the condition and at the time it left the factory. The test is conducted by applying the load in direct tension to a straight length of chain with a uniform rate of speed on a standard chain testing machine.

REACH:
The distance between the upper and lower bearing (load) points of a sling leg.

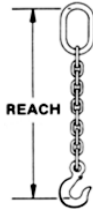

CERTIFIED

CHAIN SLINGS: Welded or Mechanical Assembly. A signed Test Certificate is required to be issued by the Sling Manufacturer for every alloy chain sling delivered to the end user. The Mechanical Chain Sling Test Certificate attests that all components used to assemble the sling have all been previously proof tested to 200% of WLL by the Sling Manufacturer. Welded Chain Sling Test Certificates verifies that the sling has been fully proof tested as an assembly to 200% of WLL following the heat treating process. There is a permanently affixed metal identification tag with a stamped individual serial number corresponding to the identification tag number on the Test Certificate. The tag is also stamped with the slings rated working load limit, size of chain, reach, number of legs or branches, grade, and Sling Manufacturers name or logo. This information must also be supplied on the Test Certificate.

Glossary of Most Common Chain Terms



SELF LOCKING HOOK: A hook design which closes when under tension and cannot be released until load is put down. Not to be used in choking or side load application.

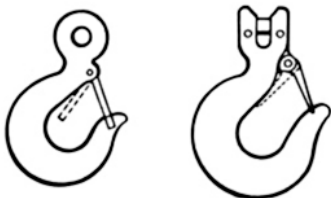

RETAINER LATCH: A spring loaded latch which prevents the hook from slipping off the load before the sling is tensioned. Only designed to keep chain from disengaging in slack condition.



SIZE: Chain size or trade size is the diameter of the stock from which the chain link is made.



WARNING

Glossary of Most Common Chain Terms



Eye Type



Clevis Type

SLING HOOK: The most common sling attachment used to connect the sling to the load. It has a full wide throat with a provision for a retainer latch.

MAGNET CHAIN (MAG CHAIN):

Commonly referred to as “mag chain”, magnet chain is used in steel industries, scrap yards and other various applications.

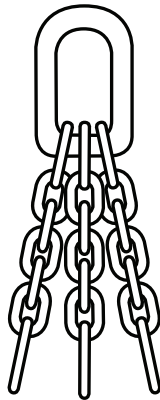

Glossary of Most Common Chain Terms

How to Measure Chain:

Dimensions shown are nominal and all weights are approximate.

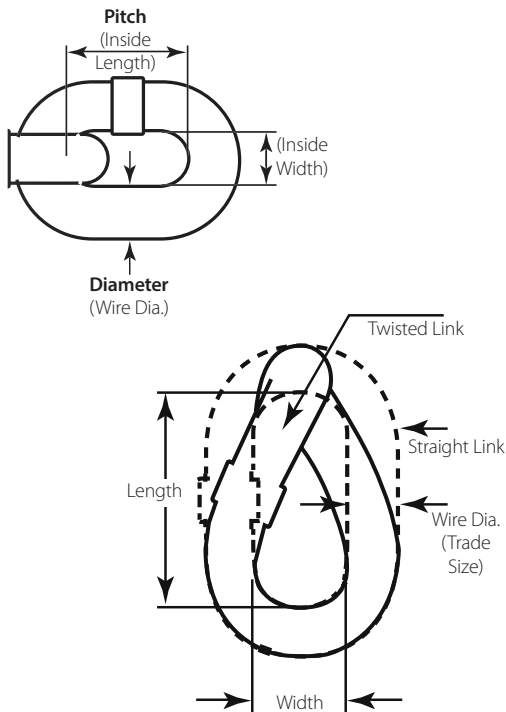

WARNING

44 Failure to read, understand and follow the instructions in this booklet could result in serious physical injury and property damage.

Glossary of Most Common Chain Terms

Slings & D/d Ratio – Alloy Chain Slings

D/d ratio is the diameter of curvature around which a sling is bent affecting its capacity. The upper case 'D' refers to the diameter of the object to which the sling hitch is applied, and the lower case 'd' represents the diameter of the chain link of the sling.

Alloy Chain D/d Ratio Efficiency

D/d Ratio	% of Rated Capacity
Less than 2	Not Recommended
2	60
3	70
4	80
5	90
6 & Greater	100

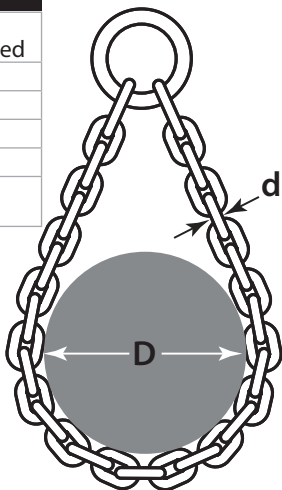

D/d De-rating Recommendations
of Basket Hitch according to the
NACM & ASME B30.9

Glossary of Most Common Chain Terms

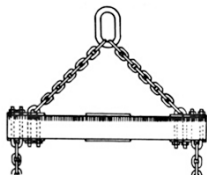

SPREADER BEAM: A structural steel beam generally suspended by a two legged sling. Used to eliminate compressive forces which could deform the load.

For more information on spreader beams, please refer to the Peerless Below-the-Hook & Material Handling Equipment catalog.

TAG LINE: A rope attached to one or both ends of a load to control rotational movements.

WORKING LOAD LIMIT: The maximum load in pounds that a user should ever apply to chain is called its Working Load Limit, or Rated Capacity. W.L.L applies to new chain and assumes that the load is applied in direct tension to a straight, untwisted length of chain without impact.

Metric Conversion	
Metric - English	English - Metric
1 kg. = 2.204 lb. mass	1 lb. mass = 0.45 kg
1 mm = 0.03937 in.	1 in. = 25.4 mm
1 M = 39.37 in.	1 ft = 0.30 M
1 Newton = 0.224 lb. force	1 lb. force = 4.46 Newtons



WARNING

Industry Standards

Peerless Industrial Group, Inc.

Peerless Alloy Chain

Industry Standards

The American Society of Mechanical Engineers (ASME) developed standards that apply specifically for the use, maintenance, inspection and application of alloy chain, components and alloy chain slings.

ASME B30.9 2018 Slings

ASME B30.10 2019 Hooks

ASME B30.26 2015-R Rigging Hardware

ASME P30.1 2019 Planning for Load Handling Activity

OSHA 1910.84

Manufacturers Recommendations

**THIS INFORMATION CONSISTS OF GENERAL GUIDELINES ONLY.
REFER TO CURRENT OSHA, ANSI & ASME STANDARDS FOR COMPLETE
SPECIFICATIONS.**

Peerless Custom Lifting and Below-the-Hook Information

Industry Standards

The American Society of Mechanical Engineers (ASME) developed standards that apply specifically to the devices Peerless Industrial Group designs and manufacturers. These standards serve as a guide to government authorities, manufacturers, purchasers and operators of below-the-hook lifting devices.

ASME B30.20 2018

- Provides detailed information on the classifications, marking, construction, installation, inspection, testing, maintenance and operation of below-the-hook lifting devices.

ASME B30.20-BTH-1 2020

- Provides detailed information on the design criteria of below-the-hook lifting devices.



WARNING

Peerless Custom Lifting and Below-the-Hook Information

Markings, Identification and General Construction

The rated load of the lifting device is visibly marked on the main structure of the device, as well as on a tag attached to the lifter. If the below-the-hook lifting device consists of individually detachable lifters, then each of the individual lifters shall be marked and tagged with their individual rated loads.

All Peerless Industrial Group below-the-hook lifting devices are tagged with the following information:

- Manufacturer's name and address
- Serial number
- Lifter weight, if over 100 lbs. (45 kg)
- Cold current (amps) (when applicable)
- Rated voltage (when applicable)
- Rated load
- Manufacture date
- ASME BTH-1 Design category
- ASME BTH-1 Service class

**THIS INFORMATION CONSISTS OF GENERAL GUIDELINES ONLY.
REFER TO CURRENT OSHA, ANSI & ASME STANDARDS FOR COMPLETE
SPECIFICATIONS.**

Peerless Custom Lifting and Below-the-Hook Information

Markings, Identification and General Construction

(Continued): All Peerless structural and mechanical lifting devices are designed and manufactured by qualified personnel. Peerless designs are in accordance with ASME BTH-1 and take into consideration the stresses that result from the application of the rated load along with the weight of the actual lifter and are designed to ASME BTH-1 Design Category B. Service Class is determined by taking into consideration the fatigue life criteria based on the expected number of load cycles.

Design Category

Design category B shall be utilized when the size, scale, and variation of loads applied to the lifter are not always predictable or clearly defined, and where the environmental and loading conditions vary or could be severe.

Service Class

Service Class is determined by the specified fatigue life of the lifter.

- Service Class 0 is 0 to 20,000 load cycles.
- Service Class 1 is 20,001 to 100,000 load cycles.
- Service Class 2 is 100,001 to 500,000 load cycles.
- Service Class 3 is 500,001 to 2,000,000 load cycles.
- Service Class 4 is over 2,000,000 load cycles.



WARNING

Peerless Custom Lifting and Below-the-Hook Information

Service Class Life

Cycles per Day	Desired Life (Years)				
	1	5	10	20	30
5	0	0	0	1	1
10	0	0	1	1	2
25	0	1	1	2	2
50	0	1	2	2	3
100	1	2	2	3	3
200	1	2	3	3	4
300	2	3	3	4	4
750	2	3	4	4	4
1,000	2	3	4	4	4

All welding shall be in accordance with ANSI/AWS D14.1 and ASME BTH-1

Exposed moving parts such as gears, projecting shafts and chain drives that constitute a hazard under normal operating conditions are guarded.

Electrical equipment and wiring shall comply with ANSI/NFPA 70 and ASME BTH-1.

FOR INFORMATION ON MODIFICATIONS/REPAIRS TO YOUR LIFTING DEVICE, CONTACT PEERLESS INDUSTRIAL GROUP TO ENSURE COMPLIANCE WITH THE CURRENT ASME STANDARDS.

THIS INFORMATION CONSISTS OF GENERAL GUIDELINES ONLY. REFER TO CURRENT OSHA, ANSI & ASME STANDARDS FOR COMPLETE SPECIFICATIONS.

Peerless Custom Lifting and Below-the-Hook Information

Proof Test

100% OF ALL PEERLESS BELOW-THE-HOOK LIFTING DEVICES ARE PROOF-TESTED TO 125% CAPACITY AND CERTIFICATES SUPPLIED AT NO ADDITIONAL CHARGE.

Requirements and Recommendations

Requirements of the ASME standard are noted by the word **shall**.

Recommendations of the ASME standard are noted by the word **should**.

Operating Practices

Operation Practices for Lifting Devices: Below-the-hook lifting devices shall only be operated by the following qualified personnel:

- Personnel designated to operate the lifter.
- Trainees who are under the direct supervision of designated personnel.
- Personnel designated to maintenance and/or conduct testing on the lifter.
- Personnel designated to inspect the lifter.

The below-the-hook lifting device shall not be overloaded beyond its manufactured rated capacity nor shall it be utilized to handle any load that it was not designed to handle.



WARNING

Peerless Custom Lifting and Below-the-Hook Information

Operating Practices for Lifting Devices (Continued):

When rigging is utilized in conjunction with the lifter, the operator shall ensure that it is not kinked and the multiple part lines are not twisted around each other.

The operator shall ensure that the load is correctly distributed for the lifter prior to the lift.

The operator shall ensure that the temperature of the load does not exceed the maximum allowable limits of the lifting device.

The operator shall ensure that the lifter is moved into place over the load in such a way as to minimize swinging.

The operator shall ensure that sudden acceleration or deceleration of the load is prevented.

The operator shall ensure that the lifter and the load do not come into contact with any obstruction.

The operator shall ensure that the load is not transported over people.

The operator shall ensure that the lifter is not utilized for side pulls or sliding the load unless explicitly authorized by a qualified person.

**THIS INFORMATION CONSISTS OF GENERAL GUIDELINES ONLY.
REFER TO CURRENT OSHA, ANSI & ASME STANDARDS FOR COMPLETE
SPECIFICATIONS.**

Peerless Custom Lifting and Below-the-Hook Information

Operating Practices for Lifting Devices (Continued):

The operator shall ensure that suspended loads are not left unattended.

The operator shall ensure that no person rides the load or the lifter.

The operation of the lifter shall be observed prior to and during a shift. Any observed deficiency in the lifter shall be examined by designated personnel. Any deficiency that constitutes a hazard shall be removed from service and tagged "Out of Service". All hazardous deficiencies shall be reported to qualified personnel for evaluation.

All loads shall be guided in a manner to avoid endangering any part of the body as it is lowered or accidentally dropped be replaced.

Miscellaneous Operating Practices: An operator shall not utilize a below-the-hook lifter that has an "out of service" tag or has been designated as non-functioning.

Only designated personnel shall be given the authority to remove "Out of service" tags on lifting devices.

When not in use the below-the-hook device should be stored in an assigned location.

Lifter markings and tags shall not be removed or damaged. Lifter markings and tags that are missing or illegible shall be replaced.



WARNING

Peerless Custom Lifting and Below-the-Hook Information

Inspection

Initial Inspection: Prior to initial use, all new, altered, modified, or repaired lifting devices shall be inspected by a qualified person to ensure compliance with the provisions of the ASME B30.20 standard.

Inspection Intervals: Below-the-hook lifters in regular service require three general types of inspection classification procedures; every lift, frequent, and periodic. The intervals for inspection are determinant upon the severity of use of the below-the-hook device, the extent of the exposure to wear and tear, as well as any history of malfunction experienced by the lifter.

Every Lift Inspection: A visual examination performed by the operator of the below-the-hook lifter conducted prior to and during every lift.

Frequent Inspections: Are comprised of visual inspections performed by either the lifter operator or other assigned personnel (records are not required by the ASME standard).

- Normal use – once a month
- Heavy use – once a week to once a monthly
- Severe use – once a day to once a week

THIS INFORMATION CONSISTS OF GENERAL GUIDELINES ONLY. REFER TO CURRENT OSHA, ANSI & ASME STANDARDS FOR COMPLETE SPECIFICATIONS.

Peerless Custom Lifting and Below-the-Hook Information

Frequent Inspections (Continued):

- Special or infrequent use – outlined as specified by a qualified individual prior to and following each use.
- Any lifter that has been idle for a period of one month to a year shall undergo a frequent inspection prior to use.

The following items listed below shall be included within the regular inspection schedule and shall be thoroughly inspected and an assessment formed as to the extent of the issue and the level of subsequent hazard resulting from it.

- Structural deformation
- Cracks in welds or structural members
- Excessive wear
- Loose or missing parts, tags, safety guards, fasteners, stops, and/or housings.
- Out of adjustment conditions that interfere with the normal operation and functionality of all mechanisms including automatic hold and release components.
- Contact Peerless Industrial Group for replacements of missing identification tags and nameplates.

Periodic Inspections: Are comprised of visual inspections performed by assigned personnel who record the current condition of the below-the-hook lifter in order to provide the basis for a continuing program of recorded evaluation. Dated reports for periodic inspections shall be maintained.



WARNING

Peerless Custom Lifting and Below-the-Hook Information

Periodic Inspections (Continued):

- Normal use – annual inspection typically performed on-site.
- Heavy use – disassembly by a qualified individual should be performed semi-annually in order to facilitate a detailed inspection.
- Severe use - disassembly by a qualified individual should be performed quarterly in order to facilitate a detailed inspection.
- Special or infrequent use – outlined as specified by a qualified individual prior to and following each use.
- Any lifter that has been idle for a period of one year or more shall undergo a periodic inspection prior to use.

Below-the-hook lifting devices shall undergo a thorough inspection based upon the previously defined intervals of every lift, frequent, and periodic. Any and all issues such as the following (as listed below) shall be investigated and a conclusion made as to if the extent of the issue and to if it is severe enough in its nature to represent a hazard. Dated inspection reports of the following critical items shall be made.

- All requirements outlined within the frequent inspection process.
- Missing or loose nuts, bolts, or fasteners.
- Fractured gears, pulleys, sheaves, sprockets, bearings, chain and belts.

THIS INFORMATION CONSISTS OF GENERAL GUIDELINES ONLY. REFER TO CURRENT OSHA, ANSI & ASME STANDARDS FOR COMPLETE SPECIFICATIONS.

Peerless Custom Lifting and Below-the-Hook Information

Periodic Inspections (Continued):

- Excessive wear of linkages, gears, pulleys, sprockets, sheaves, chain, belts, bearings, hardware, and other mechanical parts.
- Excessive wear at the bail or other load bearing points.

All repairs or modifications shall be documented on dated inspection reports.

Maintenance

Preventive Maintenance: A preventive maintenance program shall be established and be based on recommendations made by Peerless Industrial Group. It can be determined to be appropriate as designated by a qualified person to add to the maintenance program following a review of the use of the below-the-hook lifter.

Any hazards disclosed during an inspection shall be corrected before the lifting device is put back into service. Any repairs and/or adjustments shall be done only under the direction of or by a qualified person.

Replacement parts shall be equivalent to the Peerless Industrial Group's specifications.

For more information or to purchase a copy of the standard, visit ASME website, www.ASME.org.



WARNING

Notes:



PEERLESS®

A KITO GROUP COMPANY



Corporate Headquarters:
Winona, MN

Custom Lifting Device Manufacturing:
Mount Pleasant, PA
South Holland, IL

Distribution Centers:
Clackamas, OR
Reno, NV
Elizabethtown, PA
Dallas, TX
Necedah, WI

1416 East Sanborn Street
PO Box 5349
Winona, Minnesota
55987-0349

Phone: (800) 873-1916
Fax: (800) 356-1149
Internet: www.peerlesschain.com
Email: custserv@peerlesschain.com



Specifications are subject to change without notice.
© 2021 Peerless Industrial Group 10.20 8/21